

AC/DC2-wire Type Cylindrical Proximity Switches

Model FL7M | No-polarity 2-wire general-purpose switches are easy to use.

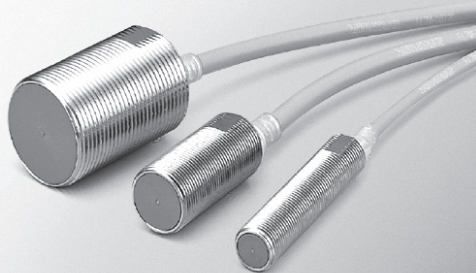

- 2-wire type for both AC and DC greatly reduces wiring man-hours
- Stable sensing area displayed by setting indicator (green/red LED)
- Indicator lamp can be seen even from the rear (pre-leaded and pre-leaded connector types)
- Compact and space-saving
- Sealed to IP67
- Enhanced circuit protection (surge absorption, load short-circuit)

- PHOTOELECTRIC SENSORS & SWITCHES
- MEASUREMENT SENSORS
- PROXIMITY SWITCHES
- LIMIT SWITCHES
- SAFETY KEY SWITCHES
- CYLINDRICAL
- SQUARE
- TECHNICAL GUIDE

FL7M (DC2)
Regular

FL7M (DC2)
Long Distance No-Polarity

FL7M (DC2)
Spatter-Guarded

FL7S

FL7M-C (DC2)
Environment-Resistant

FL7M-A (DC2)
Aluminum-Chip Resistant

FL7M (DC2)
Unshielded

FL7M (AC/DC2)

FL7M (DC3)

ORDER GUIDE

● Standard (pre-leaded) type (2 m cable)

Exterior	Sensing distance		Operation mode	Setting indicator	Catalog listing
	M12	3mm	N.O.	○	FL7M-3T7HD
	M18	7mm	N.O.	○	FL7M-7T7HD
	M30	10mm	N.O.	○	FL7M-10T7D

● Connector type

Exterior	Sensing distance		Operation mode	Setting indicator	Catalog listing
	M12	3mm	N.O.	○	FL7M-3T7HD-CN
	M18	7mm	N.O.	○	FL7M-7T7HD-CN
	M30	10mm	N.O.	○	FL7M-10T7D-CN

● Pre-leaded connector type (30 cm cable)

Exterior	Sensing distance		Operation mode	Setting indicator	Catalog listing
	M12	3mm	N.O.	○	FL7M-3T7HD-CN03
	M18	7mm	N.O.	○	FL7M-7T7HD-CN03
	M30	10mm	N.O.	○	FL7M-10T7D-CN03

● Accessories (sold separately)

Name	Appearance	O.D.	Catalog listing
Mounting bracket		For M12	FL-PA112
		For M18	FL-PA118
		For M30	FL-PA130
Protective cover		For M12	FL-PA12
		For M18	FL-PA18
		For M30	FL-PA30
Spatter-guarded protective cover		For M08	FL-PA08W
		For M12	FL-PA12W
		For M18	FL-PA18W
		For M30	FL-PA30W

SPECIFICATIONS

Catalog listing	FL7M-3T7HD(-CN,-CN03)	FL7M-7T7HD(-CN,-CN03)	FL7M-10T7HD(-CN,-CN03)
Actuation method	High-frequency oscillation type (shielded)		
Rated sensing distance	3 ±0.3 mm	7 ±0.7 mm	10 ±1 mm
Usable sensing distance	0 to 2.1 mm	0 to 4.9 mm	0 to 7 mm
Standard target object	12 x 12 mm, 1 mm thick iron	18 x 18 mm, 1 mm thick iron	30 x 30 mm, 1 mm thick iron
Differential travel	10% max. of sensing distance		
Rated supply voltage	100/200 Vac, 50/60Hz 24 Vdc		
Operating voltage range	40 to 250Vac, 20 to 250 Vdc		
Leakage current	When AC power supply is used: 2.0mA max. (100/200 Vac), When DC power supply is used: 1.1mA max. (24 Vdc)		
Control output	Switching current: 5 to 100mA (at 30 Vdc supply voltage: 5 to 20 mA) Voltage drop: When AC power supply is used 10V max., When DC power supply is used 6V max. Output dielectric strength: 250V (at both AC and DC power supplies)		
Operating frequency	When AC power supply is used 25Hz When DC power supply is used 1 kHz	When AC power supply is used 25Hz When DC power supply is used 500Hz	When AC power supply is used 25Hz When DC power supply is used 400Hz
Temperature characteristics	±10% max. for the range of -25 to +70°C when +25°C is taken as standard temperature in sensing distance.		±10% max. for the range of -10 to +60°C when +25°C is taken as standard temperature in sensing distance.
Supply voltage characteristics	± 1% max. with +15% voltage fluctuation with rated supply voltage as standard voltage in sensing distance		
Indicator lamps	Operation indication: Lights (red or green) at output Setting indication: Lights (green) in stable sensing area		
Operating temperature range	-25 to +70°C		-10 to +60°C
Insulation resistance	50 MΩ min. (at 500 Vdc)		
Dielectric strength	4,000 Vac, 50/60 Hz for 1 minute		
Vibration resistance	10 to 55 Hz, 1.5 mm peak-to-peak amplitude, 2 hrs in X, Y and Z directions		
Shock resistance	980 m/s ² 10 time in X, Y and Z directions		
Protection	IP67 (IEC standard), IP67G (JEM standard)		
Weight	Standard (pre-leaded type) Approx. 90 g Main unit with 2 m pre-leaded cable	Approx. 160 g Main unit with 2 m pre-leaded cable	Approx. 270 g Main unit with 2 m pre-leaded cable
Circuit protection	Surge absorption, load short-circuit protection (at 20 to 40 Vdc)		
Wiring method	Connector, pre-leaded connector, pre-leaded		
Material	Switch	Ni-plated brass	
	Case	Sensing face	PBT
		Housing	-CN:Ni-plated Zn, -CN03:polyester elastomer
	Connector	Holder	PBT
		Contact	-CN:Sn-plated brass, -CN03:Gold-plated brass

ABOUT SETTING INDICATION

The proximity switch can detect objects reliably by bringing the proximity switch close to the target object and setting the switch at the position where the indicator lamp changes from red to green.

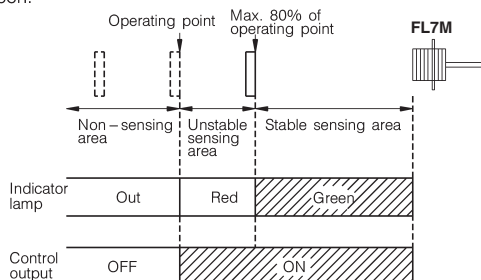

Note: When the target object is made of a different material such as aluminum, copper and stainless steel to the standard target object (iron), the setup point where the indicator lamp changes color is shorter than 80% maximum.

SENSING AREA (typical)

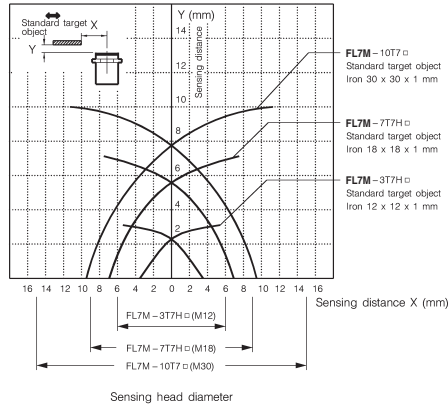

SENSING DISTANCE ACCORDING TO MATERIAL & SIZE OF OBJECT (typical)

● FL7M-3T7H □

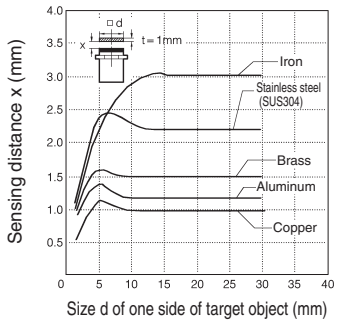

● FL7M-7T7H □

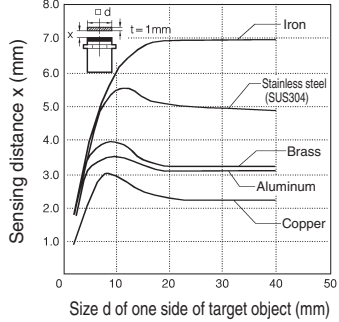

● FL7M-10T7 □

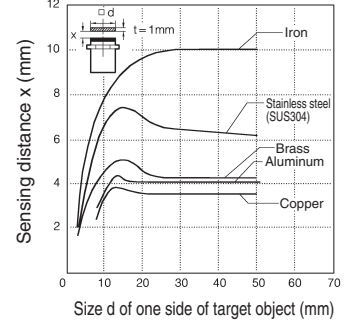

VOLTAGE DROP (typical)

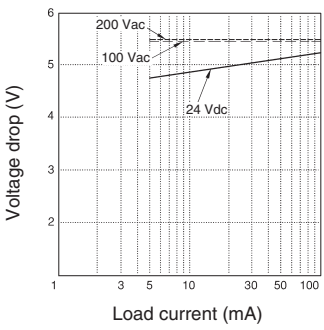

LEAKAGE CURRENT (typical)

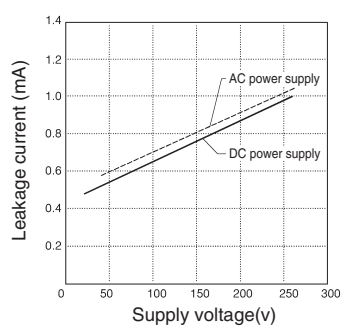

EXTERNAL DIMENSIONS

(unit: mm)

Standard (prelead) type

FL7M-3T7HD

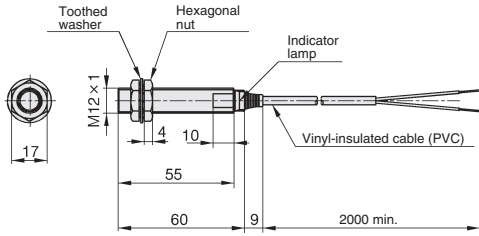

Vinyl-insulated cable (oil-resistant: 0.3 mm², 60/0.08 dia., 2-core) dia. 4. Cap color: orange.

FL7M-7T7HD

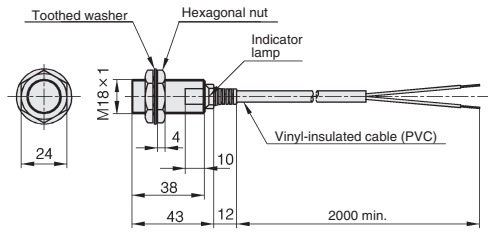

Vinyl-insulated cable (oil-resistant: 0.5 mm², 45/0.12 dia., 2-core) dia. 6. Cap color: orange.

FL7M-10T7D

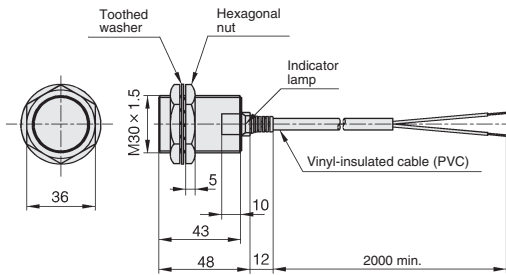

Vinyl-insulated cable (oil-resistant: 0.5 mm², 45/0.12 dia., 2-core) dia. 6. Cap color: orange.

Connector type

FL7M-3T7H□-CN

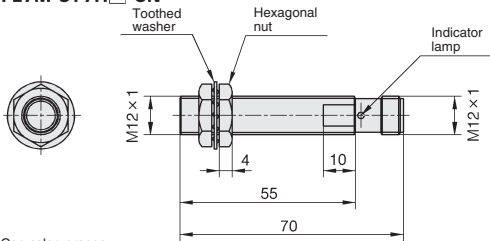

Cap color: orange.

FL7M-7T7H□-CN

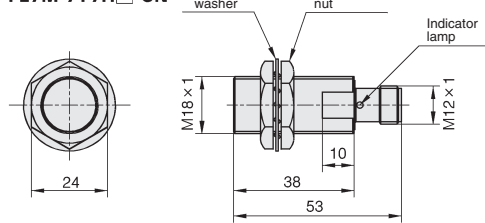

Cap color: orange.

FL7M-10T7□-CN

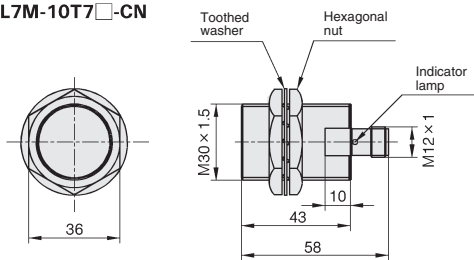

Cap color: orange.

Note:

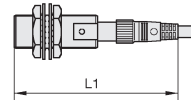

When using a straight-type connector, dimension L1 is the overall length plus about 30 mm.

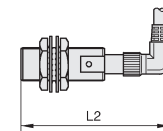

When using an angled connector, dimension L2 is the overall length plus 20 mm.

PHOTOELECTRIC
SENSORS &
SWITCHES

MEASUREMENT
SENSORS

PROXIMITY
SWITCHES

LIMIT
SWITCHES

SAFETY
KEY SWITCHES

CYLINDRICAL

SQUARE

TECHNICAL
GUIDE

FL7M (DC2)
Regular

FL7M (DC2)
Long-Distance/No-Polarity

FL7M (DC2)
Spatter-Guard

FL7S

FL7M-C (DC2)
Environment-Resistant

FL7M-A (DC2)
Aluminum-Chip Resistant

FL7M (DC2)
Unshelved

FL7M (AC/DC2)

FL7M (DC3)

Connector
with cable



See page
F-001

● Prelead connector type

FL7M-3T7H□-CN03

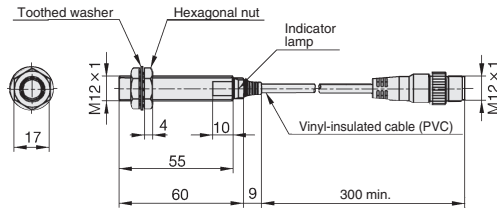

Vinyl-insulated cable (oil-resistant: 0.3 mm², 60/0.08 dia., 2-core) dia. 4. Cap color: orange.

FL7M-10T7□-CN03

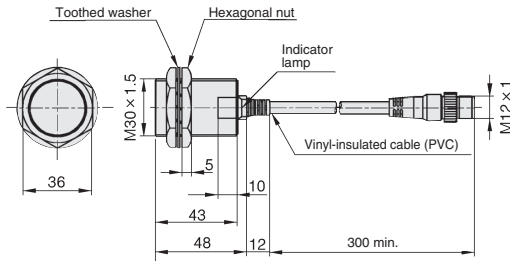

Vinyl-insulated cable (oil-resistant: 0.5 mm², 45/0.12 dia., 2-core) dia. 6. Cap color: orange.

FL7M-7T7H□-CN03

(unit: mm)

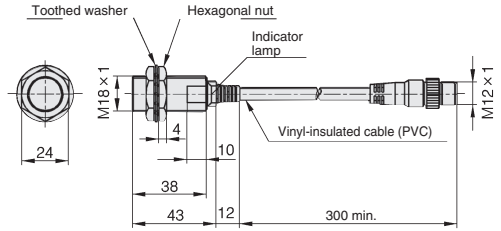

Vinyl-insulated cable (oil-resistant: 0.5 mm², 45/0.12 dia., 2-core) dia. 6. Cap color: orange.

■ MOUNTING BRACKET (sold separately)

Mounting brackets are made of polyacetal resin. Two screws and two washers are provided for each bracket.

FL-PA118 and FL-PA130 screw holes are oblong.

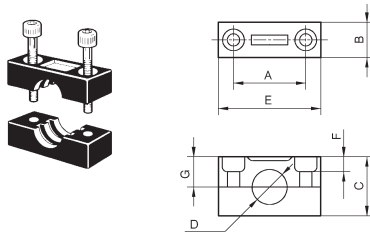

Catalog listing	Dimensions (mm)							Screw size	
	A	B	C	D	E	F	G	Dia.	Neck
FL-PA112	25	12	20	12dia.	36	6	9.5	M4	25
FL-PA118	30/32	15	30	18dia.	45	7.5	14.5	M5	35
FL-PA130	40/45	15	50	30dia.	60	10	24.5	M5	55

Allowable tightening torque of bracket screws

Catalog listing	Max. torque (N·m)
FL-PA112	0.98
FL-PA118	1.5
FL-PA130	1.5

■ PROTECTIVE COVER (sold separately)

Protective covers made of polyacetal resin are available for shielded models. Select a model according to the switch's external dimensions.

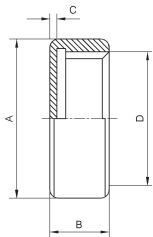

Catalog listing	Dimensions (mm)			
	A	B	C	D
FL-PA12	14dia.	5	0.5	M12x1
FL-PA18	21dia.	6	0.5	M18x1
FL-PA30	33dia.	8	1.5	M30x1.5

■ SPATTER-GUARDED PROTECTIVE COVER (sold separately)

Spatter-guarded protective covers made of fluorine resin and designed especially for shielded switches are available. Select a model according to the switch's external dimensions.

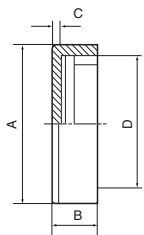

Catalog listing	Dimensions (mm)			
	A	B	C	D
FL-PA08W	10dia.	5	0.5	M8x1
FL-PA12W	15dia.	5	0.7	M12x1
FL-PA18W	22dia.	6	0.7	M18x1
FL-PA30W	34dia.	8	1.5	M30x1.5

WIRING DIAGRAMS

Preleaded type

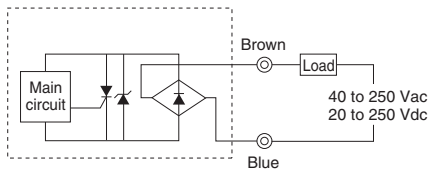

- The load may be connected to either pole.
- The LED operates normally during a load short circuit, so check the wiring if the output is wrong.
- Fasten connectors tightly by hand.

Preleaded connector type

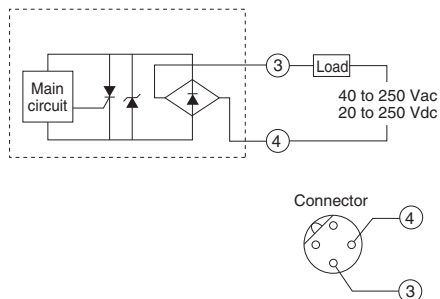

CONNECTOR SPECIFICATIONS¹⁾

Item	Specifications
Insulation resistance	Max. 100 MΩ (by 500 Vdc megger)
Dielectric strength	1,500 Vac for 1 minute (between contacts, and between contact and connector housing)
Initial contact resistance	Max. 40 mΩ (with 3A current to connected male and female connectors. Semiconductor lead-specific resistance not included.)
Mating/unmating force	0.4 to 4.0 N per contact
Mating cycles	50
Connector nut tightening torque	Min. 0.8 N·m *2
Cable pullout strength	Min. 100 N
Vibration resistance	10 to 55 Hz, 1.5 mm peak-to-peak amplitude, for 2 hours each in X, Y and Z directions
Impact resistance	300 m/s ² , 3 times each in X, Y and Z directions
Protective structure	IP67
Ambient operating temperature	-10 to +70°C
Ambient storage temperature	-20 to +80°C
Ambient operating humidity	Max. 95% RH
Material Contacts:	Gold-plated brass Contact holder: Glass-lined polyester resin Housing: Polyester elastomer Coupling: Ni-plated brass O-ring: NBR



Note 1: Specifications assume Azbil male/female connectors.

Note 2: The recommended torque is 0.4 to 0.6 N·m. If fastened poorly, the IP67 protection is lost, or looseness occurs. Fasten the connector securely by hand.

CABLE WITH CONNECTOR

Be sure to use a Model PA5 connector with cable when connecting a preleaded connector or connector-type switch.

● Model PA5 connector with cable

Shape	Power supply	Cord properties	Cord length	Catalog listing	Lead colors
	DC	Vinyl-insulated cord with high resistance to oil and vibration (UL/NFPA79 CM, CL3)	2 m	PA5-4JSX2SK	1: brown, 2: white, 3: blue, 4: black
			5 m	PA5-4JSX5SK	1: brown, 2: white, 3: blue, 4: black
			2 m	PA5-4JLX2SK	1: brown, 2: white, 3: blue, 4: black
			5 m	PA5-4JLX5SK	1: brown, 2: white, 3: blue, 4: black

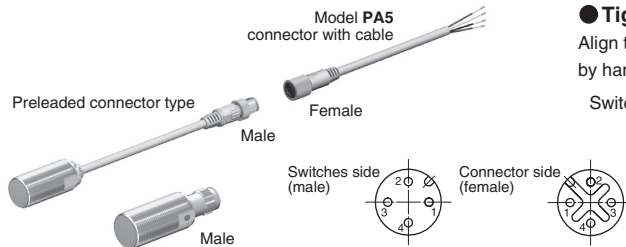

● Tightening the connector

Align the grooves and rotate the fastening nut on the PA5 connector by hand until it fits tightly with the connector on the switches side.

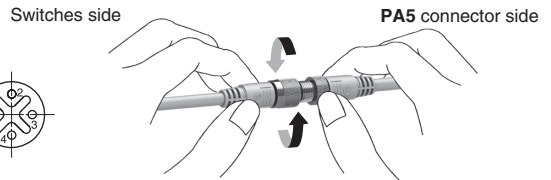

PRECAUTIONS FOR USE

1. Mounting

Catalog listing	Max. tightening torque (N·m)
FL7M-3T7H□	20
FL7M-7T7H□	70
FL7M-10T7□	180

Note: The table shows the allowable tightening torque when toothed washers (provided) are used.

The allowable tightening torque varies depending on the materials and surface conditions of the mounting plates, mounting housings, nuts, washers and other parts used for the switch. Check that the torque is appropriate for the actual combination of parts used before putting the switch into operation.

2. Influence of surrounding metal

Metal other than the target object surrounding the switch may influence operating characteristics. Leave space between the switch and surrounding metal as shown below. Shaded areas indicate surrounding metal other than the target object.

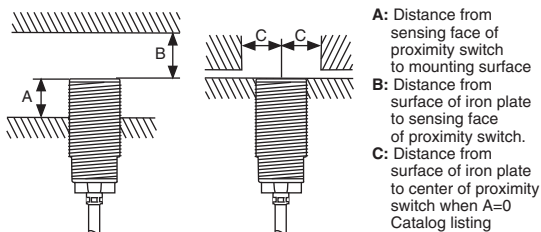

Catalog listing	A(mm)	B(mm)	C(mm)
FL7M-3T7H□	0	8	9
FL7M-7T7H□	0	20	13.5
FL7M-10T7□	0	40	22.5

3. Mutual interference prevention

When mounting proximity switches either parallel to or facing each other, mutual interference may cause the switch to malfunction. Maintain at least the distances indicated in the figures below.

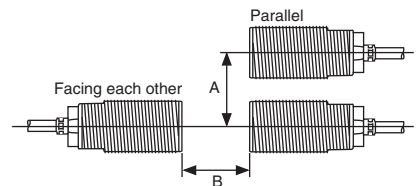

Catalog listing	A(mm)	B(mm)
FL7M-3T7H□	20	30
FL7M-7T7H□	35	50
FL7M-10T7□	70	100

4. Cautions for series or parallel connection

4.1 Series connection (AND switching circuit)

In case of either 100 Vac or 200 Vac, the voltage which is applied to the load in the ON condition is $V_L = V_S -$ (output voltage drop x number of units) (V). Note that the load will not be activated unless V_L is more than the minimum activating voltage of the load.

When more than 2 units are connected in series and are used in an AND switching circuit, the maximum number of units is 3. (Pay attention to the V_S value shown in the figure below.)

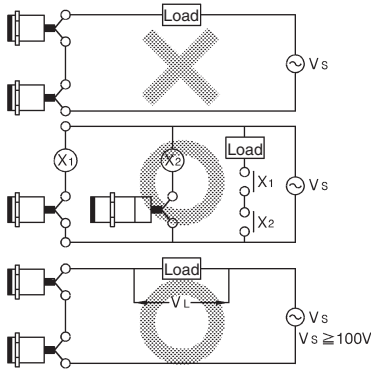

4.2 Parallel connection (OR switching circuit)

In principle it is not possible to use more than 2 proximity switches in parallel as an OR switching circuit. A parallel connection can be used only if A and B do not operate at the same time and if it is not necessary to hold the load. However, consumption current (leakage current) will be multiplied by n (the number of proximity switches), and recovery failure will occur more easily.

If A and B operate at the same time and if it is necessary to retain the load, a parallel connection cannot be used. Under these conditions, when A is turned ON, the voltage at both ends of A and B drops to approx. 10V, allowing load current to flow through A. When a target object approaches B, the switching element of B cannot be activated because the voltage at both ends of B is too low. When A is again turned OFF, the voltage at both ends of A and B increases to the power supply voltage, and at this point B can be turned ON for the first time.

During this time, since there is a period (approx. 10 ms) when both A and B are OFF, the load is momentarily reset. In order to retain the load, use a relay as shown below.

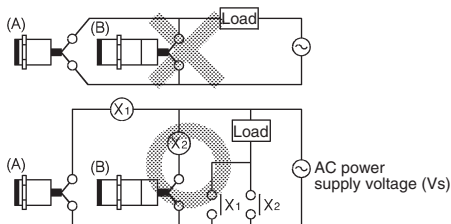

Before use, thoroughly read the "Precautions for use" and "Precautions for handling" in the Technical Guide on pages C-095 to C-101 as well as the instruction manual and product specification for this switch.

5. Loads that cause inrush current

When the proximity switch is connected to a load such as an electromagnetic switch, lamp or motor that causes inrush current, use the switch within the rated current, which includes the inrush current.

6. Connection to power supply and load

Be sure to connect the proximity switch to the power supply via the load. If the switch is connected directly to the power supply, the switch will be damaged. Also, output does not have polarity, so the load can be connected to either side of the power supply. However, we recommend connecting the load to the non-grounded side to prevent short-circuiting of the power supply if a ground fault caused by damage to the proximity switch occurs.

7. Operation upon power ON

After the power is turned ON, it takes at most 80 ms until the proximity switch is ready for sensing. If the load and the proximity switch use different power supplies, be sure to turn the proximity switch ON before turning the load ON.

8. Influence of leakage current

A minimal current flows as leakage current for operating the circuits even when the proximity switch is OFF. Keep this in mind when turning off connected loads.

9. Minimum cable bend radius (R)

The minimum bend radius (R) of the cable is 3 times the cable diameter. Take care not to bend the cable beyond this radius. Also, do not excessively bend the cable within 30 mm of the cable lead-in port.

PHOTOELECTRIC
SENSORS &
SWITCHES

MEASUREMENT
SENSORS

PROXIMITY
SWITCHES

LIMIT
SWITCHES

SAFETY
KEY SWITCHES

CYLINDRICAL

SQUARE

TECHNICAL
GUIDE

FL7M (DC2)
Regular

FL7M (DC2)
Long-Distance No-Polarity

FL7M (DC2)
Spatter-Guard

FL7S

FL7M-C (DC2)
Environment-Resistant

FL7M-A (DC2)
Aluminum-Chip Resistant

FL7M (DC2)
Unshielded

FL7M (AC/DC2)

FL7M (DC3)

Connector
with cable



See page
F-001

Please read "Terms and Conditions" from the following URL before ordering and use.

<https://www.azbil.com/products/factory/order.html>

*[Notice] Specifications are subject to change without notice.
No part of this publication may be reproduced or duplicated
without the prior written permission of Azbil Corporation.*

Other product names, model numbers and company names may be trademarks of the respective company.

Azbil Corporation

Advanced Automation Company

Yamatake Corporation changed its name to Azbil Corporation on April 1, 2012.

1-12-2 Kawana, Fujisawa
Kanagawa 251-8522 Japan

URL: <https://www.azbil.com>

1st Edition : Jan. 2018